

# ISO

**PL** Montaż zależny jest od opcji jakie zostały wybrane dla danego wyrobu.

**EN** The methods of assembly depend on the options you have selected for the product.

**DE** Montage ist von der Ausstattung des Produkts abhängig.

**FR** Le montage dépendent des options choisies.

**PL** Opcjonalnie **EN** Optionally **DE** Optional **FR** Optionnellement

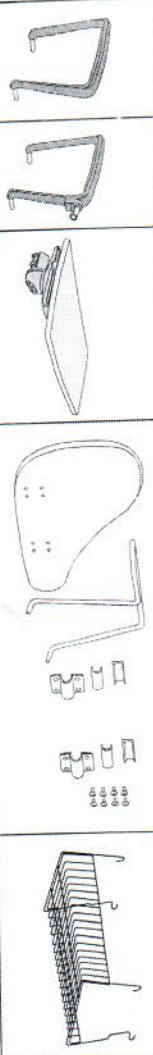

**PL** Instrukcja montażu **EN** Assembly manual **DE** Montageanleitung **FR** Notice de montage

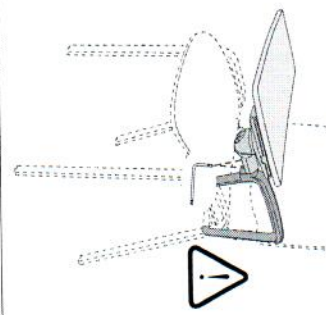
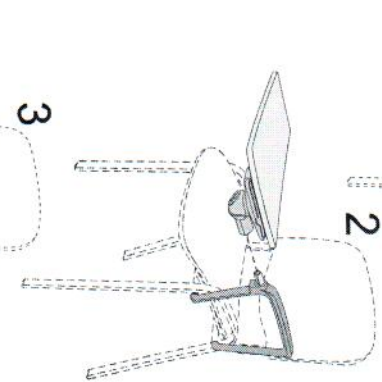
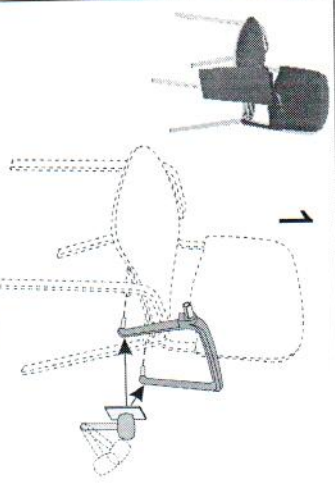
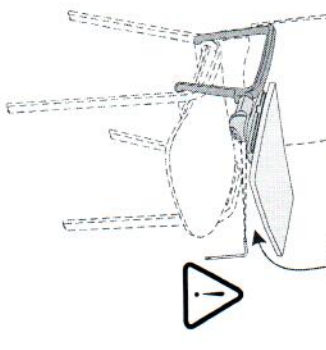
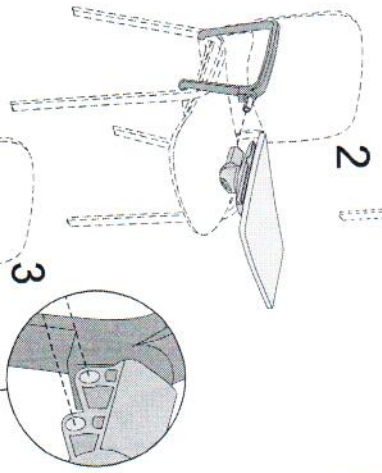
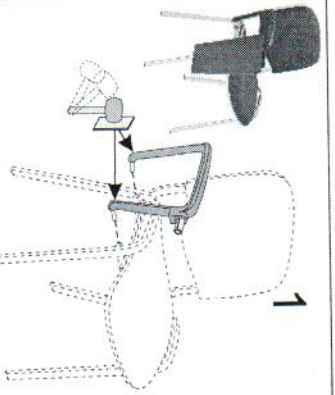
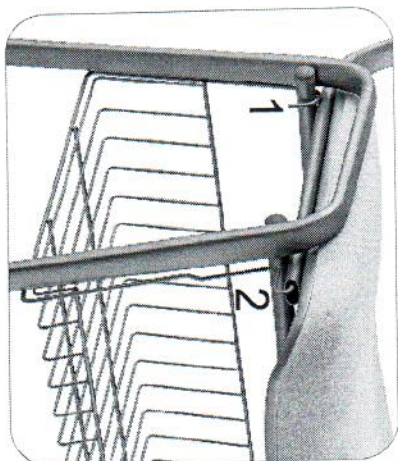
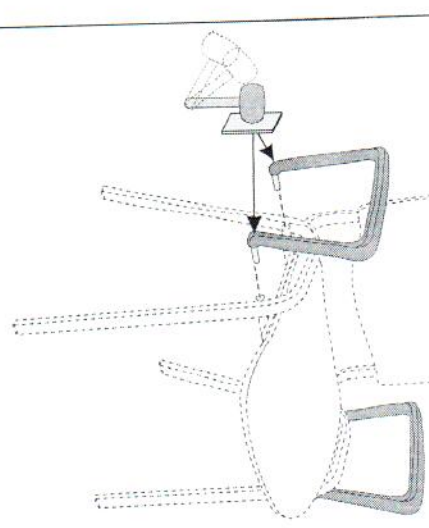

**PL** Zakres regulacji **EN** Adjustment range **DE** Einstellungsbereich **FR** Amplitude de réglages

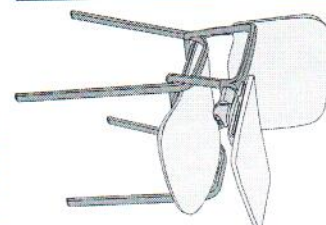
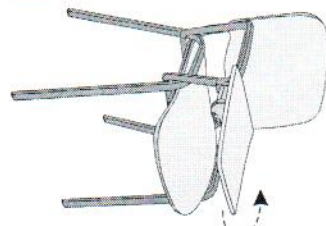
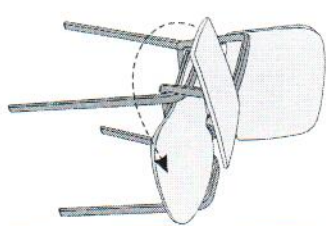
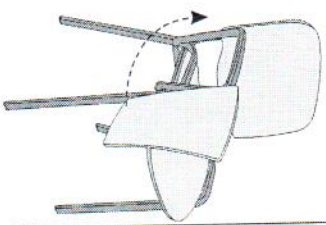

PL Instrukcja montażu

EN Assembly manual

DE Montagenanleitung

FR Notice de montage



1

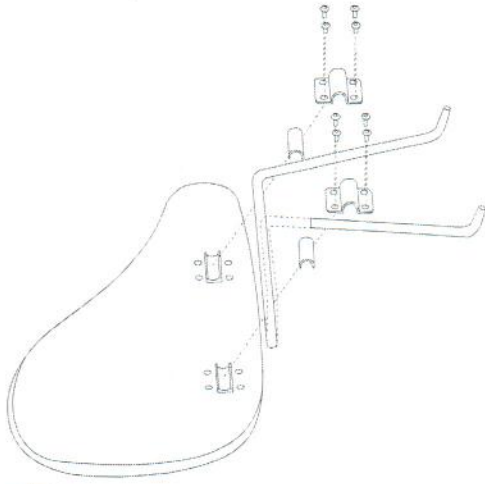

2

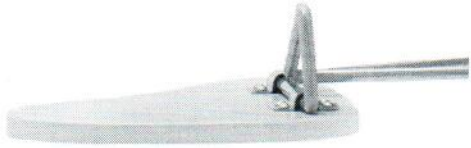

3

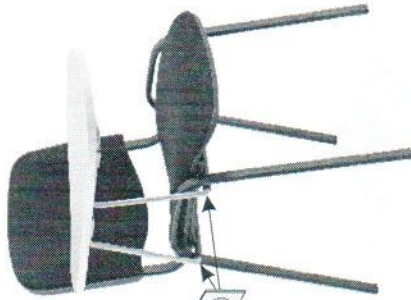

PL Zakres regulacji

EN Adjustment range

DE Einstellungsbereich

FR Amplitude de réglages

